

Data Sheet

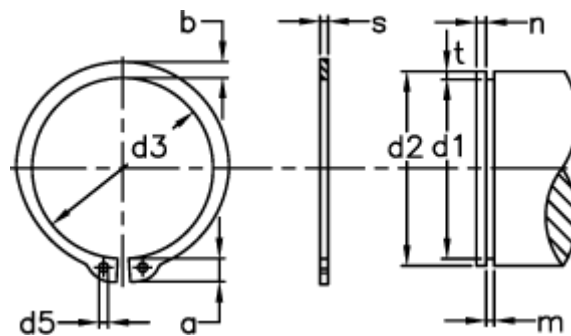

Article number: 0109044
 Description: Retaining ring AS 27x2.0
 Spring steel
 Note: Fitted with ZGA pliers

Measures



a max	= 6.6	Description	= AS 27	s	= 2.00
AN mm ²	= 62.0	FN kN	= 10.30	t	= 0.75
B	= 2.78	FRg kN	= 10.6	tol	= -0.21
b	= 3.4	FR kN	= 45.5	tol	= -0.07
d1	= 25.5	g	= 1.5	tol	= +0,21 -0,42
d2	= 27	m min	= 2.15	Tong	= ZGA-2
d3	= 24.7	n abl x 1000	= 25	Weight kg/1000	= 3.85
d5 min	= 2.0	Nominal drive	= 2.3		